

Total metal

Metal bottom box: strong rustproof, safe and durable Material: Q195 Cold-rolled steel plate The high strength of the box is not easy to be deformed, and the line is overloaded. with IP30 protection degree Inner folding crimping technology: safe and strong, strong resistance to deformation Anti-rust process: through 72 hours of professional shipping anti-corrosion test



SGDB2 Series Distribution Box

Technical data

Standard	IEC60439-3
Approval	CE
Modules (No.)	4,6,8,10,12,14,16,18,22
Rated current In(A)	63,100,125
Color	Grey
Color of door	Grey
Mounting type	Surface
Degree of protection	IP30
Material	Iron
Fire resistance	650°C/30s
Ambient temperature (°C)	-5-+40, max.95% humidity
Storage temperature (°C)	-40~+75°C



SGDB2

Number of module	Plastic base	Rated Current In(A)	Color of door
4	SGDB2-04A	63/100/125A	Grey
6	SGDB2-06A	63/100/125A	Grey
8	SGDB2-08A	63/100/125A	Grey
10	SGDB2-10A	63/100/125A	Grey
12	SGDB2-212A	63/100/125A	Grey
14	SGDB2-214A-C	63/100/125A	Grey
16	SGDB2-216A-D	63/100/125A	Grey
18	SGDB2-218A-D	63/100/125A	Grey
22	SGDB2-222A-C	63/100/125A	Grey

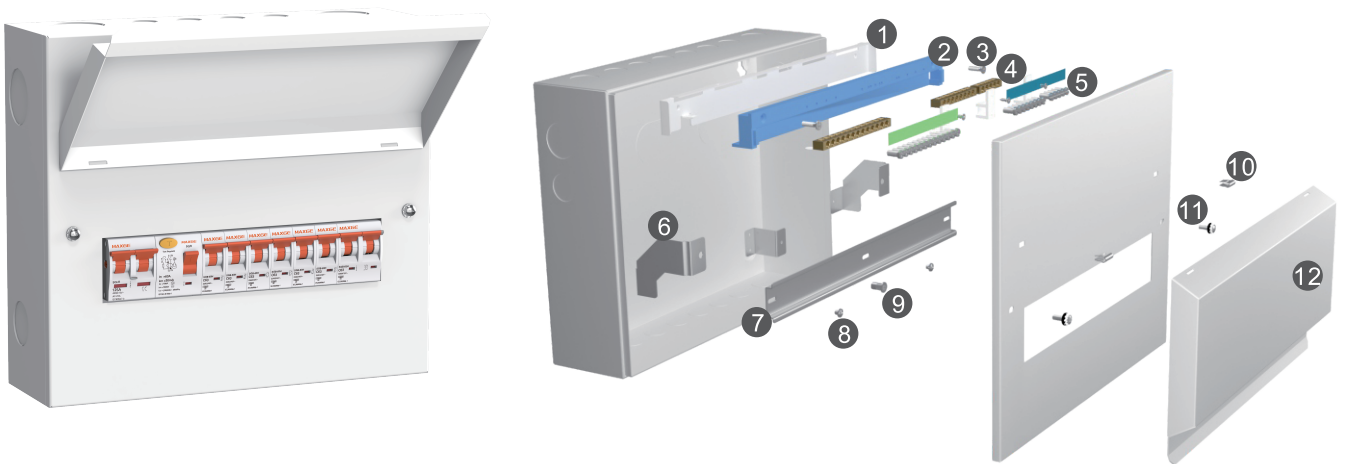

1. Plastic Strip Support

2. Plastic Strip

3. Flat Semi-Pecessed Hole Screw

4. Brass Terminal Block

5. Round M-Shape Screw

6. Din Rail Support on Left and Right

7. Din Rail

8. M4x4

9. Screw

10. Hinge

11. Metal Front Cover Screw and Spring

12. PC Window

Metal Base Dimension

Specification	L	W	H
4ways	150	260	116
6ways	186	260	116
8ways	222	260	116
10ways	258	260	116
12ways	294	260	116
14ways	330	260	116
16ways	366	260	116
18ways	402	260	116
22ways	474	260	116

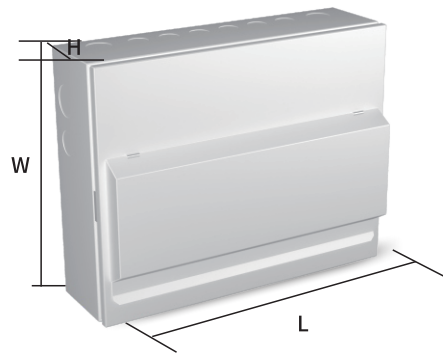

PRODUCT DISPLAY (TYPE A)

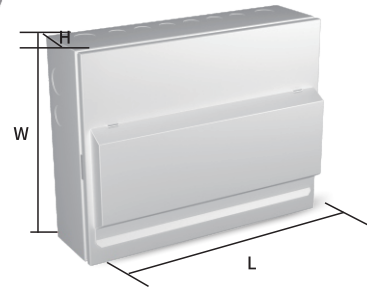
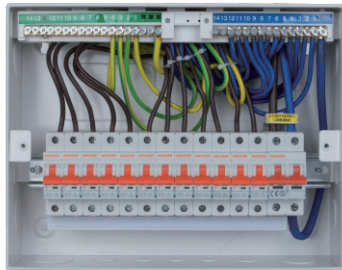

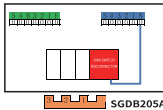
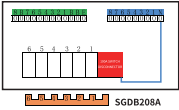
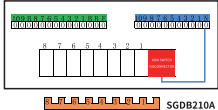
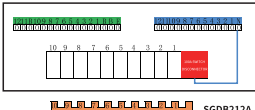
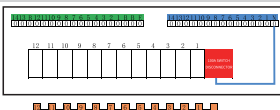
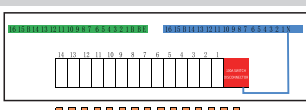
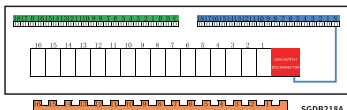
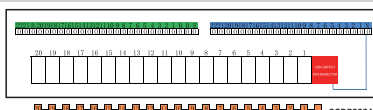
Specification	L	W	H	Board
SGDB205A (5ways)	148	260	116	
SGDB208A (8ways)	222	260	116	
SGDB210A (10ways)	258	260	116	
SGDB212A (12ways)	294	260	116	
SGDB214A (14ways)	330	260	116	
SGDB216A (16ways)	366	260	116	
SGDB218A (18ways)	402	260	116	
SGDB222A (22ways)	474	260	116	

PRODUCT DISPLAY (TYPE A1)

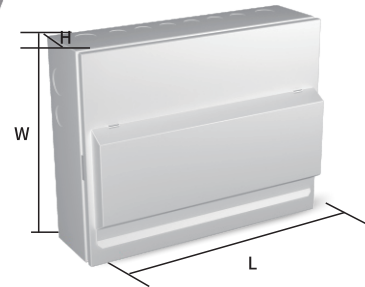
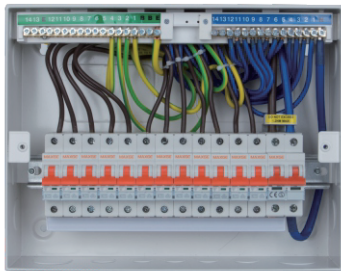

Specification	L	W	H	Board
SGDB210A (10ways)	148	260	116	 SGDB210A-1
SGDB212A (12ways)	222	260	116	 SGDB212A-1
SGDB214A (14ways)	258	260	116	 SGDB214A-1
SGDB216A (16ways)	294	260	116	 SGDB216A-1
SGDB218A (18ways)	330	260	116	 SGDB218A-1
SGDB222A (22ways)	366	260	116	 SGDB222A-1

PRODUCT DISPLAY (TYPE B)

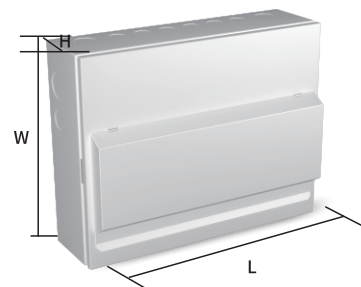
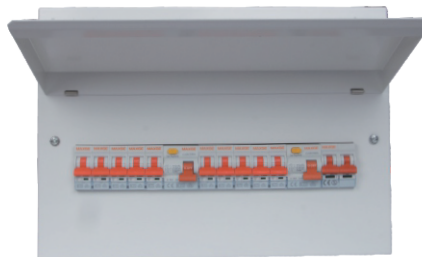
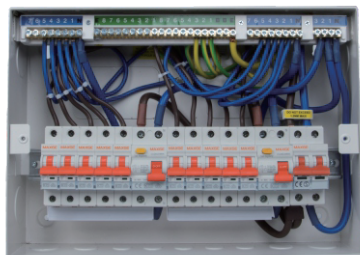

Specification	L	W	H	Board
SGDB214A (14ways)	330	260	116	<p>SGDB214B</p>
SGDB216A (16ways)	366	260	116	<p>SGDB216B</p>
SGDB218A (18ways)	402	260	116	<p>SGDB218B</p>
SGDB222A (22ways)	474	260	116	<p>SGDB222B</p>

PRODUCT DISPLAY (TYPE C)

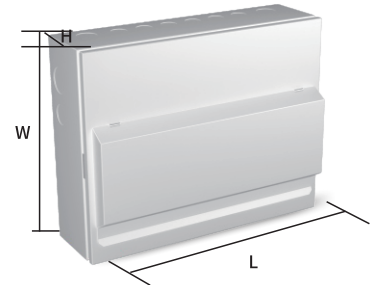
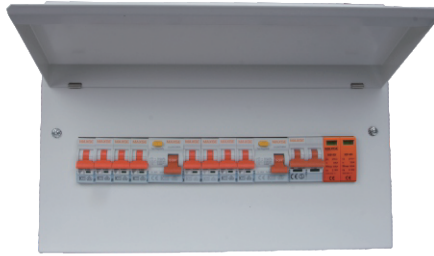
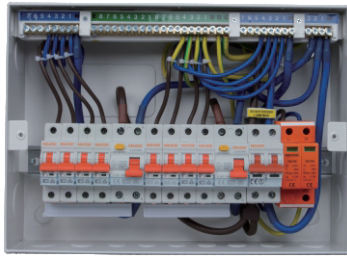

Specification	L	W	H	Board
SGDB214A (14ways)	330	260	116	
SGDB218A (18ways)	402	260	116	
SGDB222A (22ways)	474	260	116	

PRODUCT DISPLAY (TYPE D1)

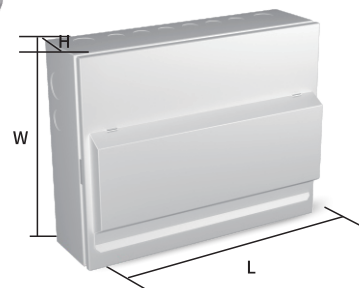
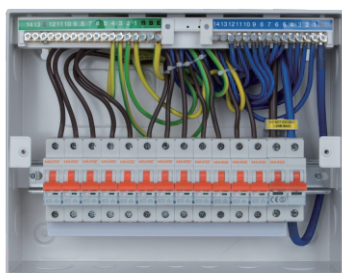

Specification	L	W	H	Board
SGDB214A (14ways)	330	260	116	 SGDB214D-1
SGDB216A (16ways)	366	260	116	 SGDB216D-1
SGDB218A (18ways)	402	260	116	 SGDB218D-1 type 1: 6x5x3 type 2: 5x5
SGDB222A (22ways)	474	260	116	 SGDB222D-1

PRODUCT DISPLAY (TYPE D)

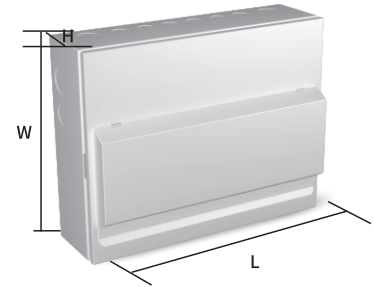
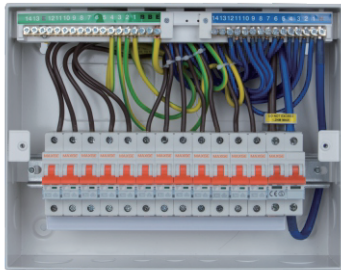

Specification	L	W	H	Board
SGDB218A (18ways)	402	260	116	